

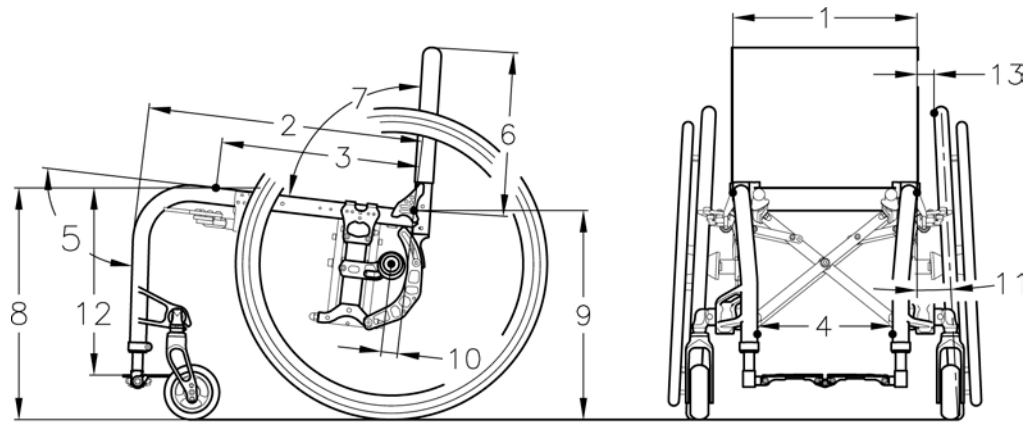

## B FRAME MEASUREMENTS 1/2



1. Seat Width  12.5"(32.0cm)  13 3/8"(34.0cm)  14 1/8"(36.0cm)  15.0"(38.0cm)  15 3/4"(40.0cm)  
 16.5"(42.0cm)  17 1/4"(44.0cm)  18 1/8"(46.0cm)

\$ STD

2. Frame Depth &  
3. Seat Depth

		Seat Depth					
Frame Depth	STD Frame 20"(51cm)	<input type="checkbox"/> 13 3/8"(34.0cm)	<input type="checkbox"/> 14 1/8"(36.0cm)	<input type="checkbox"/> 15.0"(38.0cm)	<input type="checkbox"/> 15 3/4"(40.0cm)		
	Long Frame 22 3/4"(58cm)	<input type="checkbox"/> 15 3/4"(40.0cm)	<input type="checkbox"/> 16.5"(42.0cm)	<input type="checkbox"/> 17 1/4"(44.0cm)	<input type="checkbox"/> 18 1/8"(46.0cm)	<input type="checkbox"/> 18 7/8"(48cm)	

\$ STD

\$ STD

4. Footrest Style &  
Footrest Width

Footrest Style : Center Joint Folding Foot Plate only Adj. Angle & Height  
 Footrest Width : Your seat width minus 3.5" only

\$ STD

		Your Seat Width							
		12.5"(32.0cm)	13 3/8"(34.0cm)	14 1/8"(36.0cm)	15.0"(38.0cm)	15 3/4"(40.0cm)	16.5"(42.0cm)	17 1/4"(44.0cm)	18 1/8"(46.0cm)
Footrest Width		9.0"(23.0cm)	9 7/8"(25.0cm)	10 5/8"(27.0cm)	11 3/8"(29.0cm)	12 1/8"(31.0cm)	13"(33.0cm)	13 3/4"(35.0cm)	14.5"(37.0cm)

5. Frame Bend Angle

95° Only

\$ STD

### Frame Angle to the Ground

		Your Seat Depth							
		13 3/8"(34.0cm)	14 1/8"(36.0cm)	15.0"(38.0cm)	15 3/4"(40.0cm)	16.5"(42.0cm)	17 1/4"(44.0cm)	18 1/8"(46.0cm)	18 7/8"(48.0cm)
Seat Bucket	0"(0cm)	95°	95°	95°	95°	95°	95°	95°	95°
	0.5"(1.2cm)	93°	93°	93°	93°	93°	93°	93°	93°
	1.0"(2.5cm)	91°	91°	91°	91°	92°	92°	92°	92°
	1.5"(3.8cm)	89°	89°	89°	90°	90°	90°	90°	90°
	2.0"(5.1cm)	86°	87°	87°	88°	88°	88°	89°	89°
	2.5"(6.4cm)	84°	85°	85°	86°	86°	87°	87°	87°
	3.0"(7.6cm)	82°	83°	83°	84°	85°	85°	85°	86°
	3.5"(8.9cm)	80°	81°	81°	82°	83°	83°	84°	84°
4.0"(10.2cm)	78°	79°	79°	80°	81°	82°	82°	83°	

6. Backrest Height

12.5"(32.0cm)  13 3/8"(34.0cm)  14 1/8"(36.0cm)

← Adj. range →

15.0"(38.0cm)  15 3/4"(40.0cm)  16.5"(42.0cm)

← Adj. range →

\$ STD

7. Backrest Angle

Fixed Backrest 87° from seat sling

\$ STD

NOTE

## B FRAME MEASUREMENTS 2/2

8. Front Seat Height  16.5"(42.0cm) \*1  17.0"(43.0cm) \*1  17 1/4"(44.0cm)  17 3/4"(45.0cm)  
 18 1/8"(46.0cm)  18 1/2"(47.0cm)  18 7/8"(48.0cm) \*2  19 1/4"(49.0cm) \*2  
 19 5/8"(50.0cm) \*2  
**\*1: STD Frame Only**  
**\*2: Long Frame Only**

\$ STD

### Front Seat height Range

		Front Seat Height								
		16.5"(42.0cm)	17.0"(43.0cm)	17 1/4"(44.0cm)	17 3/4"(45.0cm)	18 1/8"(46.0cm)	18 1/2"(47.0cm)	18 7/8"(48.0cm)	19 1/4"(49.0cm)	19 5/8"(50.0cm)
Caster & Forks	3" Caster & STD Forks	<input type="checkbox"/> STD FRAME ONLY	<input type="checkbox"/> STD FRAME ONLY	<input type="checkbox"/>	<input type="checkbox"/>	<input type="checkbox"/>	<input type="checkbox"/> LONG FRAME ONLY	<input type="checkbox"/> LONG FRAME ONLY		
	4" Caster & STD Forks		<input type="checkbox"/> STD FRAME ONLY	<input type="checkbox"/> STD FRAME ONLY	<input type="checkbox"/>	<input type="checkbox"/>	<input type="checkbox"/> LONG FRAME ONLY	<input type="checkbox"/> LONG FRAME ONLY		
	5" Caster & STD Forks			<input type="checkbox"/> STD FRAME ONLY	<input type="checkbox"/> STD FRAME ONLY	<input type="checkbox"/>	<input type="checkbox"/>	<input type="checkbox"/>	<input type="checkbox"/> LONG FRAME ONLY	<input type="checkbox"/> LONG FRAME ONLY

9. Rear Seat Height  14.5"(37.0cm)  15.0"(38.0cm)  15 3/8"(39.0cm)  15 3/4"(40.0cm)  16 1/8"(41.0cm)  
 16.5"(42.0cm)  17.0"(43.0cm)  17 1/4"(44.0cm)  17 3/4"(45.0cm)

\$ STD

### Rear Seat height Range

		Rear Seat Height								
		14.5"(37.0cm)	15.0"(38.0cm)	15 3/8"(39.0cm)	15 3/4"(40.0cm)	16 1/8"(41.0cm)	16.5"(42.0cm)	17.0"(43.0cm)	17 1/4"(44.0cm)	17 3/4"(45.0cm)
Rear Tire Size	24"x1"(540)	<input type="checkbox"/>	<input type="checkbox"/>	<input type="checkbox"/>	<input type="checkbox"/>	<input type="checkbox"/>	<input type="checkbox"/>			
	24"x1 3/8"(540)		<input type="checkbox"/>	<input type="checkbox"/>	<input type="checkbox"/>	<input type="checkbox"/>	<input type="checkbox"/>			
	25"x1"(559)		<input type="checkbox"/>	<input type="checkbox"/>	<input type="checkbox"/>	<input type="checkbox"/>	<input type="checkbox"/>	<input type="checkbox"/>		
	24"x2"(540)			<input type="checkbox"/>	<input type="checkbox"/>	<input type="checkbox"/>	<input type="checkbox"/>	<input type="checkbox"/>		
	26"x1"(590)			<input type="checkbox"/>	<input type="checkbox"/>	<input type="checkbox"/>	<input type="checkbox"/>	<input type="checkbox"/>	<input type="checkbox"/>	
	25"x1.95"(559)				<input type="checkbox"/>	<input type="checkbox"/>	<input type="checkbox"/>	<input type="checkbox"/>	<input type="checkbox"/>	<input type="checkbox"/>

10. Center of Gravity  1 1/8"(3.0cm)  1.5"(4.0cm)  2.0 (5.0cm)  2 3/8"(6.0cm)  
 2 3/4"(7.0cm)  3 1/8"(8.0cm)

\$ STD

11. Camber Angle  0°  2°  4°

\$ STD

12. Seat to Footrest ( )  
 \*Adj. range : 13.0" - 17.5" (33cm-45cm)

\$ STD

\*Measure vertical from top of seat sling at front edge to top of foot plate.

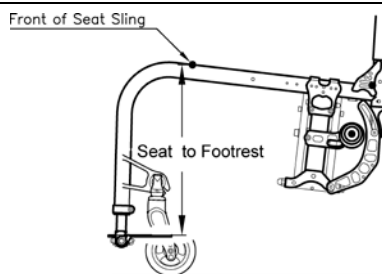

13. Inside Wheel Clearance  3/4"(2.0cm)  1.0"(2.5cm)  1 1/4"(3.0cm)

\$ STD

NOTE

# COLOR SWATCH

## ANODIZED COLORS



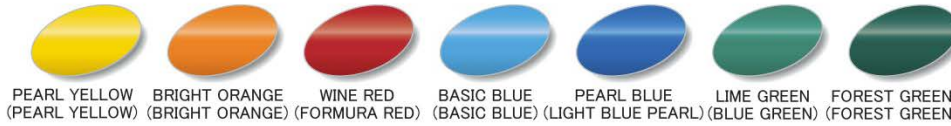

## PAINT – STANDARD COLORS



Effective Date 2023

**F WHEELS**

WHEELS																		
<b>Wire Wheels</b>	<input type="checkbox"/> 24" (540)		\$ NCO															
	<input type="checkbox"/> 25" (559)	.....	\$ NCO															
	<input type="checkbox"/> 26" (590)		\$ NCO															
<b>Y-360 Billet Wheels</b> *Max. Capacity 220Lbs *Camber 0-2" max *Not for Sports or Rugged use	<input type="checkbox"/> 25" (559) ..... Style <input type="checkbox"/> Saw Blade		\$ 1,495															
<b>Y-360 Billet Wheels MOD Style</b> *Max. Capacity 220Lbs *Camber 0-2" max *Not for Sports or Rugged use	<input type="checkbox"/> 25" (559) Only Style <input type="checkbox"/> Tribal Sun <input type="checkbox"/> Girls <input type="checkbox"/> Eagle <input type="checkbox"/> Holy Cross <input type="checkbox"/> Hono(Flames) ..... Specify Powder Coat Color for Insert Only ( ) *Choose from Frame Colors		\$ 1,783															
<b>Extra Options for</b>		<input type="checkbox"/> Powder-Coated Spokes Only ( ) *Choose from Frame Colors <b>(\$250 up charge)</b>																
<b>Spinergy Spox 18 Spokes</b> 	<input type="checkbox"/> 24" (540) <input type="checkbox"/> 25" (559) <input type="checkbox"/> 26" (590) Spoke Color <input type="checkbox"/> Black With Silver Hub <input type="checkbox"/> Red With Black Hub <input type="checkbox"/> Yellow With Black Hub <input type="checkbox"/> Blue With Black Hub <input type="checkbox"/> White With Black Hub .....		\$ 998															
	<input type="checkbox"/> Custom Color Spoke Pattern	<table border="1"> <thead> <tr> <th colspan="2"></th> <th>Left Wheel</th> <th>Right Wheel</th> </tr> </thead> <tbody> <tr> <td>Spokes</td> <td>Inside</td> <td></td> <td></td> </tr> <tr> <td>Color</td> <td>Outside</td> <td></td> <td></td> </tr> <tr> <td>Hub Color</td> <td></td> <td><input type="checkbox"/> Black/<input type="checkbox"/> Silver</td> <td><input type="checkbox"/> Black/<input type="checkbox"/> Silver</td> </tr> </tbody> </table>			Left Wheel	Right Wheel	Spokes	Inside			Color	Outside			Hub Color		<input type="checkbox"/> Black/ <input type="checkbox"/> Silver	<input type="checkbox"/> Black/ <input type="checkbox"/> Silver
		Left Wheel	Right Wheel															
Spokes	Inside																	
Color	Outside																	
Hub Color		<input type="checkbox"/> Black/ <input type="checkbox"/> Silver	<input type="checkbox"/> Black/ <input type="checkbox"/> Silver															
<b>Spinergy LX 12 Spokes</b> 	<input type="checkbox"/> 24" (540) <input type="checkbox"/> 25" (559) <input type="checkbox"/> 26" (590) Spoke Color <input type="checkbox"/> Black With Silver Hub <input type="checkbox"/> Red With Black Hub <input type="checkbox"/> Yellow With Black Hub <input type="checkbox"/> Blue With Black Hub <input type="checkbox"/> White With Black Hub <input type="checkbox"/> Neon Green With Black Hub <input type="checkbox"/> Pink With Black Hub <input type="checkbox"/> Orange With Black Hub <input type="checkbox"/> Purple With Black Hub		\$ 1,252															
	<input type="checkbox"/> Custom Color Spoke Pattern	<table border="1"> <thead> <tr> <th colspan="2"></th> <th>Left Wheel</th> <th>Right Wheel</th> </tr> </thead> <tbody> <tr> <td>Spokes</td> <td>Inside</td> <td></td> <td></td> </tr> <tr> <td>Color</td> <td>Outside</td> <td></td> <td></td> </tr> <tr> <td>Hub Color</td> <td></td> <td><input type="checkbox"/> Black/<input type="checkbox"/> Silver</td> <td><input type="checkbox"/> Black/<input type="checkbox"/> Silver</td> </tr> </tbody> </table>			Left Wheel	Right Wheel	Spokes	Inside			Color	Outside			Hub Color		<input type="checkbox"/> Black/ <input type="checkbox"/> Silver	<input type="checkbox"/> Black/ <input type="checkbox"/> Silver
		Left Wheel	Right Wheel															
Spokes	Inside																	
Color	Outside																	
Hub Color		<input type="checkbox"/> Black/ <input type="checkbox"/> Silver	<input type="checkbox"/> Black/ <input type="checkbox"/> Silver															
<b>Spinergy X-Laced Sport Lite Extreme "XSLX" 24 Spokes</b> 	<input type="checkbox"/> 24" (540) <input type="checkbox"/> 25" (559) <input type="checkbox"/> 26" (590) Spoke Color <input type="checkbox"/> Black With Silver Hub <input type="checkbox"/> Red With Black Hub <input type="checkbox"/> Yellow With Black Hub <input type="checkbox"/> Blue With Black Hub <input type="checkbox"/> White With Black Hub <input type="checkbox"/> Neon Green With Black Hub <input type="checkbox"/> Pink With Black Hub <input type="checkbox"/> Orange With Black Hub <input type="checkbox"/> Purple With Black Hub		\$ 1,210															
	<input type="checkbox"/> Custom Color Spoke Pattern	<table border="1"> <thead> <tr> <th colspan="2"></th> <th>Left Wheel</th> <th>Right Wheel</th> </tr> </thead> <tbody> <tr> <td>Spokes</td> <td>Inside</td> <td></td> <td></td> </tr> <tr> <td>Color</td> <td>Outside</td> <td></td> <td></td> </tr> <tr> <td>Hub Color</td> <td></td> <td><input type="checkbox"/> Black/<input type="checkbox"/> Silver</td> <td><input type="checkbox"/> Black/<input type="checkbox"/> Silver</td> </tr> </tbody> </table>			Left Wheel	Right Wheel	Spokes	Inside			Color	Outside			Hub Color		<input type="checkbox"/> Black/ <input type="checkbox"/> Silver	<input type="checkbox"/> Black/ <input type="checkbox"/> Silver
		Left Wheel	Right Wheel															
Spokes	Inside																	
Color	Outside																	
Hub Color		<input type="checkbox"/> Black/ <input type="checkbox"/> Silver	<input type="checkbox"/> Black/ <input type="checkbox"/> Silver															

Valid from 2023 Prices & Specifications Are Subject To Change Without Notice.

**Spinergy Sport Lite Extreme "SLX" 24 Spoke**



24" (540)    25" (559)    26" (590)  
 Spoke Color    Black    Red    Yellow    Blue  
                     With Silver Hub   With Black Hub   With Black Hub   With Black Hub  
 White    Neon Green    Pink    Orange    Purple  
                     With Black Hub   With Black Hub   With Black Hub   With Black Hub   With Black Hub

Custom Color Spoke Pattern

		Left Wheel	Right Wheel
Spokes	Inside		
	Color		
Hub Color		<input type="checkbox"/> Black/ <input type="checkbox"/> Silver	<input type="checkbox"/> Black/ <input type="checkbox"/> Silver

\$ 1,166

\$ 1,276

**Spinergy Lite Extreme "XLX" X-Laced-12 Spoke**



24" (540)    25" (559)    26" (590)  
 Spoke Color    Black    Red    Yellow    Blue  
                     With Silver Hub   With Black Hub   With Black Hub   With Black Hub  
 White    Neon Green    Pink    Orange    Purple  
                     With Black Hub   With Black Hub   With Black Hub   With Black Hub   With Black Hub

Custom Color Spoke Pattern

		Left Wheel	Right Wheel
Spokes	Inside		
	Color		
Hub Color		<input type="checkbox"/> Black/ <input type="checkbox"/> Silver	<input type="checkbox"/> Black/ <input type="checkbox"/> Silver

\$ 1,210

\$ 1,320

**Spinergy Blade "LXL" 18 Spoke**



24" (540)    25" (559)    26" (590)  
 Spoke Color    Black    Red    Yellow    Blue  
                     With Silver Hub   With Black Hub   With Black Hub   With Black Hub  
 White    Neon Green    Pink    Orange    Purple  
                     With Black Hub   With Black Hub   With Black Hub   With Black Hub   With Black Hub

Custom Color Spoke Pattern

		Left Wheel	Right Wheel
Spokes	Inside		
	Color		
Hub Color		<input type="checkbox"/> Black	<input type="checkbox"/> Black

\$ 1,040

\$ 1,150

**HANDRIM**

<b>Type</b>	<input type="checkbox"/> Standard For 24", 25" or 26" Wheel Anodized Black	\$ STD
	<input type="checkbox"/> Vinyl Coated For 24", 25" & 26" Wheels Not available with Y-360 Billet Wheels . . . . .	\$ 200
	<input type="checkbox"/> Spinergy Silver Brushed Anodized For 24", 25" & 26" . . . . .	\$ 176
	<input type="checkbox"/> Natural Fit For 24", 25" & 26" Wheel	
	<input type="checkbox"/> Standard Grip (Not available with short tabs.) Not available with Y-360 Billet Wheels . . . . .	\$ 570
	<input type="checkbox"/> Super Grip (Not available with short tabs.) Not available with Y-360 Billet Wheels . . . . .	\$ 645
	<input type="checkbox"/> Without Thumb Grip ( Not available with Y-360 Billet Wheels) . . . . .	\$ 338
	<input type="checkbox"/> Natural Fit(LT) For 24", 25" & 26" Wheel	
	<input type="checkbox"/> Standard Grip (Not available with short tabs.) Not available with Y-360 Billet Wheels . . . . .	\$ 629
	<input type="checkbox"/> Super Grip (Not available with short tabs.) Not available with Y-360 Billet Wheels . . . . .	\$ 706
	<input type="checkbox"/> Without Thumb Grip ( Not available with Y-360 Billet Wheels) . . . . .	\$ 400
	<input type="checkbox"/> The Surge Handrims * Not available with Y-360 Billet Wheels . . . . .	\$ 553
	<input type="checkbox"/> The Surge Handrims (LT) * Not available with Y-360 Billet Wheels . . . . .	\$ 603
	<input type="checkbox"/> Spinergy Flex Rim Available only on Spinergy LX & XLX	\$ CFP
	<input type="checkbox"/> The Q-Grip Handrims : anti-slip, latex-free, neoprene coating * Not available with Y-360 Billet Wheels	\$ 543
	<input type="checkbox"/> OMIT HANDRIMS	\$ NCO

<b>TAB LENGTH</b>	<input type="checkbox"/> Long Tab ( STD inside clearance 3/4") Not available with Y-360 Billet Wheels * . . . . .	STD
	<input type="checkbox"/> Short Tab (Inside clearance 1/2") * Not available with Natural Fit Handrim with thumb grip . . . . .	\$ STD
	<input type="checkbox"/> Short Tab (Set closest to wheel cut off excess) * Not available with Y-360 wheel . . . . .	\$ 35

**C WHEELS, TIRES & CASTERS, FORKS 2/2**

<b>TIRES</b>			
<input type="checkbox"/> High Pressure Tire	<input type="checkbox"/> 24"x1", <input type="checkbox"/> 25"x1" or <input type="checkbox"/> 26"x1"	Gray Tire with black wall Only	E2211/E2212 \$ STD
<input type="checkbox"/> High Pressure Tire	<input type="checkbox"/> 24"x1", <input type="checkbox"/> 25"x1" or <input type="checkbox"/> 26"x1"	<input type="checkbox"/> Blue <input type="checkbox"/> Red <input type="checkbox"/> Yellow	E2211/E2212 \$ 100
<input type="checkbox"/> Low Pressure Tire	<input type="checkbox"/> 24"x1-3/8" or <input type="checkbox"/> 26"x1-3/8"	Gray Only	E2211/E2212 \$ STD
<input type="checkbox"/> E2213	Flat-Free Inserts For 24"x1-3/8" Tires Only		E2211/E2213 \$ 115

<b>CASTERS</b>					
SIZE	TIRE WIDTH	HUB COLOR	TIRE COLOR	DESCRIPTION	
<input type="checkbox"/> 3"	1"	Black Hub	Black Tire Only	Polyurethane	\$ STD
<input type="checkbox"/> 3"	1"	Plastic Black Hub	Clear Tire Only	Lighted, Polyurethane	\$ 86
<input type="checkbox"/> 3"	1"	Red Hub	Red Tire Only	Polyurethane	\$ STD
<input type="checkbox"/> 3"	1"	Black Hub	Clear Tire Only	Polyurethane	\$ STD
<input type="checkbox"/> 4"	1.5"	Plastic Black Hub	Black Tire Only		\$ STD
<input type="checkbox"/> 4"	1"	Plastic Black Hub	Clear Only	Lighted, Polyurethane	\$ 86
<input type="checkbox"/> 4"	1"	Aluminum Silver Hub	Black Tire Only		\$ 209
<input type="checkbox"/> 4"	1.5"	Aluminum Silver Hub	Black Tire Only	Soft Roll	\$ 209
<input type="checkbox"/> 5"	1"	Composite Black Hub	Black Tire Only		\$ STD
<input type="checkbox"/> 5"	1"	Plastic Black Hub	Clear Tire Only	Lighted, Polyurethane	\$ 86
<input type="checkbox"/> 5"	1"	Aluminum Silver Hub	Black Tire Only		\$ 209
<input type="checkbox"/> 5"	1.5"	Aluminum Silver Hub	Black Tire Only	Soft Roll	\$ 209

<b>FORKS</b>	
<input type="checkbox"/> STD Aluminum Forks	Black Only \$ STD

**D COMPONENTS**

<b>WHEEL LOCKS</b>	
<input type="checkbox"/> Gallop Push to Lock / Anodized	\$ STD
<input type="checkbox"/> NEW Compact Scissor Lock / Anodized Black Only	\$ 146

<b>PUSH HANDLES</b>	
<input type="checkbox"/> Integrated w/Fixed Backrest Height / Anodized Black Only	\$ STD
<input type="checkbox"/> Omit Push Handle	\$ NCO

<b>NEW ARM RESTS</b>		Anodized Black Only	
<input type="checkbox"/> Fixed Tubular Armrest	Adj. Angle and Height	Height from seat sling Set at :	<input type="checkbox"/> 8" <input type="checkbox"/> 9" <input type="checkbox"/> 10" <input type="checkbox"/> 11" <input type="checkbox"/> 12" E0973 \$ 330
<input type="checkbox"/> Swing Away Tubular Armrest	Adj. Angle and Height	Height from seat sling Set at :	<input type="checkbox"/> 8" <input type="checkbox"/> 9" <input type="checkbox"/> 10" <input type="checkbox"/> 11" <input type="checkbox"/> 12" E0973 \$ 330
<input type="checkbox"/> Flip-Up Armrest	<input type="checkbox"/> w/Fixed Tubular Armrest	Height from seat sling Set at :	<input type="checkbox"/> 8" <input type="checkbox"/> 9" <input type="checkbox"/> 10" <input type="checkbox"/> 11" <input type="checkbox"/> 12" E0973 \$ 330
	Adj. Angle <input type="checkbox"/> w/ Swing Away Tubular Armrest	Height from seat sling Set at :	<input type="checkbox"/> 8" <input type="checkbox"/> 9" <input type="checkbox"/> 10" <input type="checkbox"/> 11" <input type="checkbox"/> 12" E0973 \$ 330

<b>ANTI-TIPPERS</b>	
<input type="checkbox"/> Anti-Tippers (pair) w/ Quick Release / Anodized Black Only	E0971 \$ 330
<input type="checkbox"/> Folding Anti-Tippers (pair) w/ Quick Release / Black Only	E0971 \$ 358

<b>SIDE GUARDS</b>	
<input type="checkbox"/> Adj. Height Rigid Side Guards - Black ABS Non-Removable Style Only	\$ 258

<b>SEAT CUSHION</b>		-*Please see section E for other cushion choices.-	
<input type="checkbox"/> Foam Cushion	w/Nylon Black Cover	Thickness	<input type="checkbox"/> 1" <input type="checkbox"/> 2" <input type="checkbox"/> 3" <input type="checkbox"/> 4" \$ CFP

<b>UPHOLSTERY CHOICE &amp; COLOR</b>		*Positioning Back Available. Please see Section E	
<input type="checkbox"/> Adjustable Tension Backrest	Black Color Only		\$ STD
<input type="checkbox"/> Calf Strap	<input type="checkbox"/> Black <input type="checkbox"/> Matching Fabric (\$65 up charge) -Select Fabric( )		K0038 \$ 35

NOTE

**G CHAIR OPTIONS 1 / 2**

SEAT CUSHION			
<b>SUPRACOR® WHEELCHAIR CUSHIONS</b>			
<b>Stimulite® Contoured Cushion</b> *Black Upholstery only  *Comes with Zipper Pouch <input type="checkbox"/> Extra Sensitive (\$35 up charge) <input type="checkbox"/> Sling Style Bottom (\$52 up charge) <input type="checkbox"/> Custom Size ( \$- CFP ) W(   " ) x D(   " ) <input type="checkbox"/> Extra Cover (\$120 up charge)	<input type="checkbox"/> W14"xD16" (CD1416)	.....	<b>E2603</b> \$ 707
	<input type="checkbox"/> W16"xD16" (CD1616)	.....	<b>E2603</b> \$ 707
	<input type="checkbox"/> W16"xD18" (CD1618)	.....	<b>E2603</b> \$ 707
	<input type="checkbox"/> W18"xD16" (CD1816)	.....	<b>E2603</b> \$ 707
	<input type="checkbox"/> W18"xD18" (CD1818)	.....	<b>E2603</b> \$ 707
	<input type="checkbox"/> W18"xD20" (CD1820)	.....	<b>E2603</b> \$ 714
	<input type="checkbox"/> W20"xD16" (CD2016)	.....	<b>E2603</b> \$ 714
	<input type="checkbox"/> W20"xD18" (CD2018)	.....	<b>E2603</b> \$ 714
	<input type="checkbox"/> W20"xD20" (CD2020)	.....	<b>E2603</b> \$ 734
	<b>Stimulite® Slimline Cushion</b> *Black Upholstery only  <input type="checkbox"/> Extra Sensitive (\$35 up charge) <input type="checkbox"/> Sling Style Bottom (\$52 up charge) <input type="checkbox"/> Custom Size ( \$- CFP ) W(   " ) x D(   " ) <input type="checkbox"/> Extra Cover (\$86 up charge)	<input type="checkbox"/> W14"xD16" (SM1416)	.....
<input type="checkbox"/> W16"xD16" (SM1616)		.....	<b>E2603</b> \$ 446
<input type="checkbox"/> W16"xD18" (SM1618)		.....	<b>E2603</b> \$ 446
<input type="checkbox"/> W18"xD18" (SM1818)		.....	<b>E2603</b> \$ 446
<input type="checkbox"/> W18"xD20" (SM1820)		.....	<b>E2603</b> \$ 490
<input type="checkbox"/> W20"xD16" (SM2016)		.....	<b>E2603</b> \$ 490
<input type="checkbox"/> W20"xD18" (SM2018)		.....	<b>E2603</b> \$ 490
<input type="checkbox"/> W20"xD20" (SM2020)		.....	<b>E2603</b> \$ 518
<b>Stimulite® Corbee Pediatric</b> *Black Upholstery only <input type="checkbox"/> Extra Cover (\$86 up charge)	<input type="checkbox"/> W10"xD10" (PD1010)	.....	<b>E2603</b> \$ 342
	<input type="checkbox"/> W12"xD12" (PD1212)	.....	<b>E2603</b> \$ 342
	<input type="checkbox"/> W14"xD14" (PD1414)	.....	<b>E2603</b> \$ 342
	<input type="checkbox"/> Extra Sensitive (\$35 up charge) <input type="checkbox"/> Sling Style Bottom (\$52 up charge) <input type="checkbox"/> Custom Size W(   " ) x D(   " ) ( \$- CFP )		
<b>ROHO WHEELCHAIR CUSHIONS</b>			
Choose Size	<input type="checkbox"/> <b>4" HIGH PROFILE® QUADTRO SELECT® CUSHION</b> *Black Upholstery ..... <input type="checkbox"/> Extra Cover ( \$+100 ) ..... only-		<b>E2622-2623</b> \$ 669
	<input type="checkbox"/> W12"xD12"	<input type="checkbox"/> W12"xD13"	<input type="checkbox"/> W13"xD13"
	<input type="checkbox"/> W15"xD16"	<input type="checkbox"/> W15"xD18"	<input type="checkbox"/> W16"xD15"
	<input type="checkbox"/> W18"xD16"	<input type="checkbox"/> W18"xD18"	<input type="checkbox"/> W18"xD20"
	<input type="checkbox"/> W20"xD22"	<input type="checkbox"/> W22"xD18"	<input type="checkbox"/> W22"xD20"
Choose Size	<input type="checkbox"/> <b>3" MID PROFILE® QUADTRO SELECT® CUSHION</b> *Black Upholstery only ..... <input type="checkbox"/> Extra Cover ( \$+100 )		<b>E2622-2623</b> \$ 669
	<input type="checkbox"/> W15"xD15"	<input type="checkbox"/> W15"xD16"	<input type="checkbox"/> W16"xD16"
	<input type="checkbox"/> W16"xD18"	<input type="checkbox"/> W18"xD16"	<input type="checkbox"/> W18"xD18"
Choose Size	<input type="checkbox"/> <b>2" LOW PROFILE® QUADTRO SELECT® CUSHION</b> *Black Upholstery only ..... <input type="checkbox"/> Extra Cover ( \$+100 ) .....		<b>E2622-2623</b> \$ 669
	<input type="checkbox"/> W12"xD12"	<input type="checkbox"/> W12"xD13"	<input type="checkbox"/> W13"xD13"
	<input type="checkbox"/> W15"xD16"	<input type="checkbox"/> W15"xD18"	<input type="checkbox"/> W16"xD15"
	<input type="checkbox"/> W18"xD16"	<input type="checkbox"/> W18"xD18"	<input type="checkbox"/> W18"xD20"
	<input type="checkbox"/> W20"xD18"	<input type="checkbox"/> W20"xD16"	<input type="checkbox"/> W20"xD20"
<b>THE CURVE CUSHION</b> *Black Upholstery only <input type="checkbox"/> Extra Cover ( \$+ 46	<input type="checkbox"/> W10"xD10"	<input type="checkbox"/> W10"xD11"	<input type="checkbox"/> W10"xD11"
	<input type="checkbox"/> W12"xD13"	<input type="checkbox"/> W12"xD14"	<input type="checkbox"/> W13"xD11"
	<input type="checkbox"/> W14"xD14"	<input type="checkbox"/> W14"xD15"	<input type="checkbox"/> W14"xD16"
	<input type="checkbox"/> W16"xD14"	<input type="checkbox"/> W16"xD15"	<input type="checkbox"/> W16"xD16"
	<input type="checkbox"/> W17"xD17"	<input type="checkbox"/> W17"xD18"	<input type="checkbox"/> W18"xD16"
<input type="checkbox"/> W10"xD12"	<input type="checkbox"/> W11"xD12"	<input type="checkbox"/> W12"xD12"	
<input type="checkbox"/> W13"xD12"	<input type="checkbox"/> W13"xD13"	<input type="checkbox"/> W13"xD14"	
<input type="checkbox"/> W15"xD14"	<input type="checkbox"/> W15"xD15"	<input type="checkbox"/> W15"xD16"	
<input type="checkbox"/> W16"xD17"	<input type="checkbox"/> W16"xD18"	<input type="checkbox"/> W17"xD16"	
<input type="checkbox"/> W18"xD17"	<input type="checkbox"/> W18"xD18"		



**G CHAIR OPTIONS 2 / 2**

SEAT CUSHION				
<b>Exgel Kaji Cushion</b>				
<b>For Comfortable Sitting To Prevent Pressure Sores</b>				
<input type="checkbox"/> <b>Owl Regular(1.6" Thick)</b> Incontinence Cover Only	<input type="checkbox"/> W14"xD16" <input type="checkbox"/> W15"xD16" <input type="checkbox"/> W16"xD16" <input type="checkbox"/> W18"xD16"	..... ..... ..... ..... * No Custom Sizes	<input type="checkbox"/> <b>Extra Cover \$104</b>	E2603 \$ 362 E2603 \$ 362 E2603 \$ 362 E2603 \$ 408
<input type="checkbox"/> <b>Owl High(3.1" Thick)</b> Incontinence Cover Only	<input type="checkbox"/> W14"xD16" <input type="checkbox"/> W15"xD16" <input type="checkbox"/> W16"xD16" <input type="checkbox"/> W18"xD16" <input type="checkbox"/> W18"xD18"	..... ..... ..... ..... ..... * No Custom Sizes	<input type="checkbox"/> <b>Extra Cover \$104</b>	E2603 \$ 437 E2603 \$ 437 E2603 \$ 437 E2603 \$ 495 E2603 \$ 495
<input type="checkbox"/> <b>Owl Contour(3.0" Thick)</b> Incontinence Cover Only	<input type="checkbox"/> W14"xD16" <input type="checkbox"/> W15"xD16" <input type="checkbox"/> W16"xD16" <input type="checkbox"/> W18"xD16"	..... ..... ..... .....	<input type="checkbox"/> <b>Extra Cover \$104</b>	E2603 \$ 454 E2603 \$ 454 E2603 \$ 454 E2603 \$ 495
<input type="checkbox"/> <b>Owl Deep Contour(4.3" Thick)</b>		* No Custom Sizes- Incontinence Cover Only		
<input type="checkbox"/> W14"xD16" \$518 <input type="checkbox"/> W15"xD16" \$518 <input type="checkbox"/> W16"xD16" \$518 <input type="checkbox"/> W18"xD16" \$558		<input type="checkbox"/> <b>Extra Cover \$104</b>		
<input type="checkbox"/> <b>Standard Regular(1.4" Thick)</b> Easy to Use Flat Style (superior pressure redistribution)		<b>For Pressure</b>		E2622-2623
<input type="checkbox"/> W12" x D12" \$368 <input type="checkbox"/> W13" x D13" \$368 <input type="checkbox"/> W14" x D14" \$368 <input type="checkbox"/> W14" x D16" \$368 <input type="checkbox"/> W16" x D16" \$368	<input type="checkbox"/> W16" x D17" \$368 <input type="checkbox"/> W17" x D16" \$368 <input type="checkbox"/> W17" x D17" \$368 <input type="checkbox"/> W18" x D16" \$391 <input type="checkbox"/> W18" x D18" \$391	<input type="checkbox"/> <b>Extra Cover \$104</b> * No Custom Sizes- Incontinence Cover Only		
<input type="checkbox"/> W18" x D19" \$440 <input type="checkbox"/> W18" x D20" \$440 <input type="checkbox"/> W19" x D19" \$440				
<input type="checkbox"/> <b>Standard High(2.6" Thick)</b> Incontinence Cover Only		.....		E2622
*Black Upholstery only				
<input type="checkbox"/> W12" x D12" \$383 <input type="checkbox"/> W13" x D13" \$ 383 <input type="checkbox"/> W14" x D14" \$383 <input type="checkbox"/> W14" x D16" \$ 383 <input type="checkbox"/> W16" x D16" \$383	<input type="checkbox"/> W16" x D17" \$383 <input type="checkbox"/> W17" x D16" \$383 <input type="checkbox"/> W17" x D17" \$383 <input type="checkbox"/> W18" x D16" \$460 <input type="checkbox"/> W18" x D18" \$460	<input type="checkbox"/> W18" x D19" \$512 <input type="checkbox"/> W18" x D20" \$512 <input type="checkbox"/> W19" x D19" \$512 <input type="checkbox"/> W18" x D19" \$512		
<input type="checkbox"/> <b>Extra Cover \$104</b>				
<input type="checkbox"/> <b>Standard Anti-Thrust(2.6" Thick)</b> * No Custom Sizes Incontinence Cover Only	<input type="checkbox"/> W16 x D16 \$460 <input type="checkbox"/> W18 x D16 \$500 <input type="checkbox"/> W18 x D18 \$500	Prevents Unwanted Forward Movement of lower back and hip bone	<input type="checkbox"/> <b>Extra Cover \$104</b>	
<input type="checkbox"/> <b>Lite Regular(2.2" Thick)</b>	<input type="checkbox"/> W16" x D16" \$374 <input type="checkbox"/> W18" x D16" \$397 <input type="checkbox"/> W18" x D18" \$397	* No Custom Sizes- Incontinence Cover Only		
<input type="checkbox"/> <b>Extra Cover \$104</b>				
<input type="checkbox"/> <b>Lite High(3.0" Thick)</b>	<input type="checkbox"/> W16" x D16" \$408 <input type="checkbox"/> W18" x D16" \$431 <input type="checkbox"/> W18" x D18" \$431	* No Custom Sizes- Incontinence Cover Only		
<input type="checkbox"/> <b>Extra Cover \$104</b>				